

# MS39 CC Syringe Pump

## User Manual

Version: 1.1

**MDKMed Medical Technology Co., Ltd.**  
**2025.8.7**

# Contents

1. Symbols, Graphics and Warnings .....	5
1.1. Descriptions of Graphics and Symbols .....	5
1.2. Warning .....	6
2. Terms and definitions .....	11
3. Brief Introduction and Scope of Application .....	12
3.1. Brief Introduction .....	12
3.2. Intended Purpose .....	12
3.3 Benefits of Syringe pumps .....	12
3.4 Risks of Syringe pumps .....	13
3.5 Side effects .....	13
4. Important Features .....	13
5. Specifications .....	15
5.1. Basic Specifications .....	15
5.2. Main Performance .....	15
5.3. Main Functions and Common Functions .....	19
6. Structure and Operation Interface .....	20
6.1. Structural Composition .....	20
6.2. Display and Operation Interface .....	22
7. Operation Instructions .....	22
7.1. Installation of Syringe Pump .....	23
7.2. Power on and Device Safety Self-test .....	23
7.2.1. Power on and off .....	23
7.2.2. Device safety self-test .....	23
7.3. Quick Use Guide .....	24
7.3.1. Install / Replace syringe .....	24
7.3.2. Select syringe .....	24

7.3.3. Set infusion parameters .....	25
7.3.4. Purge .....	27
7.3.5. Start infusion .....	27
7.3.6. Infusion completed .....	28
7.4. Pause or Stop Infusion .....	28
7.5. Bolus .....	29
7.5.1. Hand off bolus .....	29
7.6. Lock and Unlock Screen Function .....	30
7.7. Infusion Mode Selection and Setting .....	31
7.7.1. Dose mode .....	32
7.7.2. Drug Library mode .....	33
7.7.3. RTM mode .....	34
7.7.4. Sequence Mode .....	35
7.7.5. Loading Dose Mode .....	36
7.7.6. Intermittent mode .....	37
7.7.7. Micro mode .....	38
7.7.8. Relay mode .....	38
7.8. View Log .....	38
8. Alarms .....	39
8.1. No Syringe Alarm .....	44
8.2. Occlusion Alarm .....	44
8.3. Empty Of Syringe Alarm .....	45
8.4. End Of Infusion Alarm .....	45
8.5. Pusher Setup Fail Alarm .....	46
8.6. Battery Empty Alarm .....	46
8.7. Battery & External Power Disconnect Alarm .....	46
8.8. Motor Error Alarm .....	47
8.9. Pusher Position Error Alarm .....	47

8.10. Battery Error Alarm .....	48
8.11. KVO Alarm .....	48
8.12. KVO End Alarm .....	48
8.13. Standby End Alarm .....	49
8.14. Communication Error Alarm .....	49
8.15. Call Back Alarm .....	49
8.16. Low battery Alarm .....	50
8.17. Near End Of infusion Alarm .....	50
8.18. Near Empty Of Syringe Alarm .....	51
8.19. No AC Power Alarm .....	51
9. System Parameter setting .....	52
9.1. Bed number .....	52
9.2. Brightness .....	52
9.3. Alarm Sound Volume .....	52
9.4. Occlusion Pressure Level .....	53
9.5. Bolus Setting .....	54
9.6. Purge Setting .....	54
9.7. Call Back Time Setting .....	54
9.8. KVO setting .....	54
9.9. Auto Screen Lock Time .....	56
9.10. Near End Of Infusion Time Setting .....	56
9.11. Prime prompt switch .....	56
9.12. Night mode Setting .....	56
9.13. Date/Time Setting .....	57
9.14. History mode switch .....	58
9.15. Syringe brand .....	58
9.16. Maintenance .....	59
10. Accuracy Calibration for syringe .....	59

10.1. Automatic Accuracy Calibration for syringe ..... 59

10.2. Manual Accuracy calibration for Syringe .....60

11. Precautions for Using Disposable syringe ..... 61

12. Technical Specification .....62

13. Restore to factory setting ..... 67

14. Use, Maintenance and Removal of the Internal Battery ..... 68

15. Service and Maintenance ..... 68

16. Waste Disposal ..... 70

    16.1. Battery ..... 70

    16.2. Syringe .....70

    16.3. Syringe pump .....70











17. Electromagnetic Compatibility .....70



18. Antistatic Precautions .....75

19. Packaging and Accessories ..... 76

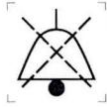
# 1. Symbols, Graphics and Warnings

## 1.1. Descriptions of Graphics and Symbols

	Caution		Read the User Manual
	Defibrillation prevention Type CF device	<b>RoHS</b>	Compliant to ROHS standards
	Date of manufacturing		Class II device
	Serial Number		Classified collection, uncontrolled discard not allowed
<b>IP24</b>	Ingress Protection Grade		AC (Alternating Current)
	DC (Direct current)		Mute
	Lithium battery		Non-ionizing electromagnetic radiation

	<p>Manufacturer</p>	<table border="1"> <tr> <td data-bbox="540 185 647 256">EU</td> <td data-bbox="647 185 757 256">REP</td> </tr> </table>	EU	REP	<p>European Representative</p>
EU	REP				
	<p>CE mark demonstrating compliance with RoHS and other EU directives</p>		<p>Medical device marking</p>		

## 1.2. Warning

Please read the following information carefully, operation that does not strictly follow the guidance will possibly damage the device or do harm to patients' health.

- 1) The Syringe Pump is intended for clinical intravenous infusion. It must either be used with a syringe that is from the list of the recommended brands or with one from other brands after calibration is performed on the device.
- 2) Untrained personnel are not allowed to operate the device. The operator must carefully read this User's Manual, so as to prevent medical accidents caused by improper operation.
- 3) To prevent fire or explosion, do not use this device in an environment where flammable or explosive matters are present.
- 4) Do not stack and use other devices that may generate external radio frequency interference or electromagnetic radiation that may affect the safe operation of this device.

- 5) The operator must use the recommended syringe calibrated in accordance with the requirements described in Section 10 Accuracy Calibration for Syringe in this manual, and make sure that the correct syringe brand and type are selected.
- 6) Unauthorized syringes are not recommended to use for infusion, otherwise it may lead to infusion inaccuracy and even become unusable.
- 7) The installation height of this device should not be more than 1 meter above or below the patient's heart. It is recommended that the syringe pump be placed at the same height as the patient's heart when used.
- 8) It is forbidden to reuse the same syringe on another infusion device.
- 9) This device cannot be used as a portable device.
- 10) It is forbidden to use sharp objects to press on the buttons or the touch screen.
- 11) The Syringe Pump must be serviced and calibrated by trained professional technicians. Before maintenance, make sure to unplug the power cable that supplies power to the device. Untrained personnel are strictly prohibited from opening the device casing, otherwise the eligibility for warranty of the device will be lost.
- 12) Please make sure to use only the parts and accessories provided by manufacturers.
- 13) When hit hard or dropped, the pump should not be used until it has been checked by trained technical staff.
- 14) Except for wiping the outer surface of the device according to Section 15 Service and Maintenance in this manual, no other part of the device shall be serviced or maintained by users. If there is any abnormality in the device, please contact the customer service of manufacturers.

- 15) During the use of the device, the device should be placed smoothly and fixed firmly.
- 16) After loading the syringe, the operator is required to check whether the liquid medicine in the syringe leaks. If there is leakage, stop using the syringe and notify the customer service of manufacturers.
- 17) Operator should set the infusion parameters strictly based on the doctor's prescriptions. Mistakes in infusion parameter settings may cause harm to patients.
- 18) When an ordinary syringe is used continuously, the syringe needs to be replaced after the infusion task is completed or the syringe is emptied to maintain a higher injection accuracy.
- 19) The pump will stop operation automatically when there is an alarm. Press the Start/Stop key to resume operation after the alarm causing condition is removed.
- 20) To avoid failure or false alarm caused by a dirty occlusion sensor, operator should wipe clean the pump on a regular basis to keep it clean. Disconnect device from MAIN supply before cleaning.
- 21) If the sound pressure level of the audible alarm is less than the environmental noise, the operator should turn the alarm volume up to ensure the alarm sound can be heard.
- 22) Pump or accessories may not be usable if their lifetime for use has expired (the lifetime for pump is 8 years). Contact manufacturers to upgrade to new products.
- 23) The device has a internal rechargeable lithium battery and its lifetime is 2 years.
- 24) Please check the voltage of the internal battery before using it for pump operation. The battery must be replaced and maintained by trained technical personnel in accordance with Section 14 Use,

Maintenance and Removal of the Internal Batteries in this manual. Replacing the battery by personnel without sufficient training will lead to risks such as over temperature, fire or explosion.

- 25) Please do not connect any other device to the USB and Type-C port other than the included DC power adapter shipped with the pump. Do not put the AC/DC adapter above the patient.
- 26) For different types of patients, different occlusion pressure Level should be set. For details, please refer to the doctor's advice.
- 27) Healthcare professional should check on the device during operation on a regular basis, and he/she should also pay attention to medication solution in the infusion set before starting the device to make sure the right medicine is in the right infusion channel.
- 28) When using this device, please do not place the power plug or other independent plug in a difficult place when it is used as a disconnecting measure.
- 29) The needle on the syringe extension line is the application part of this product.
- 30) While in normal operation, an alarm will be triggered if the pump door is opened. Please contact company for service if this alarm fails to appear.
- 31) If the sticker on the screw hole is removed, then consider the fact that the pump has been tampered with, and discontinue use.
- 32) The product is not AP or APG type device and should not be used in flammable gas environment.
- 33) Don't near active HF SURGICAL device and the RF shielded room of an ME SYSTEM for magnetic resonance imaging, where the intensity of EM DISTURBANCES is high.
- 34) Use of this device adjacent to or stacked with other device should be

avoided because it could result in improper operation. If such use is necessary, this device and the other device should be observed to verify that they are operating normally.

- 35) Use of accessories, transducers and cables other than those specified or provided by the manufacturer of this device could result in increased electromagnetic emissions or decreased electromagnetic immunity of this device and result in improper operation.
- 36) Portable RF communications device (including peripherals such as antenna cables and external antennas) should be used no closer than 30 cm (12 inches) to any part of the MS39 CC, including cables specified by the manufacturer. Otherwise, degradation of the performance of this device could result.
- 37) The EMISSIONS characteristics of this device make it suitable for use in industrial areas and hospitals (CISPR 11 class A). If it is used in a residential environment (for which CISPR 11 class B is normally required) this device might not offer adequate protection to radio-frequency communication services. The user might need to take mitigation measures, such as relocating or reorienting the device.
- 38) The ME device or ME SYSTEM is suitable for professional healthcare facility environments.
- 39) If the device needs to be used on the move (transport within the hospital): make sure the device is securely fixed and placed. If the device is changed in position, or the pump is severely shaken, the accuracy of the infusion may be affected.
- 40) Do not use unapproved cleaners, materials or chemicals as they may damage device surfaces, labels, or cause device failures.
- 41) Do not route LVP supply bag or administration set right above the pump.

- 42) Do not route the administration set in a way that presents tripping hazard and administration set break off.
- 43) Do not change the height of pump during infusion, otherwise the infusion accuracy may be affected.
- 44) When the device is powered by the internal battery, the charging indicator light is blue; When the device is powered through the net power supply, the external power indicator light will turn green. At this time, if the battery is not fully charged, the charging indicator light will turn green at the same time, and the charging indicator light will not turn on when the battery is fully charged.
- 45) Any serious incident that has occurred in relation to the device should be reported to the manufacturer and the competent authority of the Member State in which the user and/or patient is established.
- 46) Do not modify this device without authorization of the manufacturer.
- 47) If this device is modified, appropriate inspection and testing must be conducted to ensure continued safe use of the device.
- 48) If necessary, please contact the company's customer service staff to provide the relevant information of maintenance.

## 2. Terms and definitions

**Operator:** A professionally trained and qualified member of medical staff.

**Keep vein open (KVO):** After infusion is completed based on the preset parameters, the pump will automatically switch to a mode with extremely low Infusion rate and continue to run (this mode virtually does not have any treatment effect), which is to keep the IV push set and vein unobstructed and to avoid the blood flowing backwards.

**Intermediate rate:** An infusion rate of 5.00mL/h.

**Minimum rate:** An infusion rate of 1.00mL/h.

**Free-flow:** Drug solution is flowing out in an uncontrolled manner under the effect of gravity.

**VTBI:** Volume to be infusion.

### 3. Brief Introduction and Scope of Application

#### 3.1. Brief Introduction

The syringe pump is a high-accuracy infusion device. It is mainly consisted of an electrical control module and a mechanical actuation module, including subsystems such as a control system, a motor driver system, a sensing and monitoring system, an alarm system, a display system, a power system (Adapter) and etc..

#### 3.2. Intended Purpose

**Intended use:** By controlling the flow rate, the syringe pump is intended to be used for intravenous therapy at clinical service facilities on adults, pediatrics for the intermittent or continuous delivery of drug solution, medications via IV infusion route. Light and sound alarms help the users use the pumps properly.

**Indication for use:** N/A.

**Contraindications:** None.

**Intended patient population:** The target population is adults, pediatrics who need intravenous therapy, no other specific requirements.

**Intended users of the device:** The device is intended to be used by trained healthcare professionals in medical institution environments.

#### 3.3 Benefits

Expected clinical benefit: Syringe pumps provide a variety of advantages compared to manual IV push, such as:

- Automated delivery
- Precision dosage
- Avoiding medication errors
- Reducing the workload of nursing staff

Syringe pumps can deliver much smaller amounts of medicine than a manual IV push.

Thus, the use of syringe pumps could provide reliable, automated, contact-free dosing to patients with severe cases, and this helped to ease the burden on ICU nurses and other clinicians without compromising care quality,

### 3.4 Risks

Syringe pumps appear to enhance overall safety and care quality compared to manual IV administration, they are not without risk. Design issues, software bugs, and user errors continue to compromise patient safety.

We have carry out risk management throughout the design and development stage.

### 3.5 Side effects

The unintended bolus of medication might cause possible inflammation and pain at the infusion site and potential source of infection.

## 4. Important Features

- 1) **Compatible syringe sizes:** A wide range of syringe types can be automatically identified, including 2/3, 5, 10, 20, 30 and 50/60 mL.

- 2) **Accuracy:** The accuracy for infusion rate and volume both are kept within 1.5%.
- 3) **Infusion rate:** Infusion rate can be adjusted from 0.01mL/h to 2300mL/h in a continuous manner, which makes syringe pump capable of meeting various Infusion rate requirements in different infusion situations.
- 4) **Touchscreen interface:** Infusion parameters can be set by using the touch screen on the device, even with gloves on.
- 5) **Electric Drive head:** Use electric drive head to eliminate the mechanical gap when the device is started, so that the first drop of liquid medicine can be injected into the patient's body as soon as possible.
- 6) **External power supply:** An external power adapter is used, which not only removes the safety concerns of using an internal switching power source but also makes the device lighter and smaller in size.
- 7) **Battery capacity:** The rechargeable internal high-capacity Lithium battery can support normal operation for 8 hours, which is conveniently helpful during patient transport or power outage.
- 8) **Display:** LCD touch screen display offers high contrast and great visibility. Clearly visible from 5 meters away.
- 9) **Occlusion removal:** When the infusion line is occluded, the stepper motor will rotate reversely to release the pressure accumulated in the infusion line.
- 10) **Real-time pressure monitoring:** The pressure values can be monitored in real time during the infusion process, ranging from 50-1000mmHg, can be accurate to 1mmHg pressure.

## 5. Specifications

### 5.1. Basic Specifications

Dimensions	277mm×136mm×72mm (width x depth x height)
Weight	1.43 kg
Power supply	Network power supply: ~ 100V-240 V, 50/60 Hz Internal battery:  7.4 V rechargeable Lithium battery
Rate of work	45 VA
Syringe requirements	Refer to Section 11 Precautions for Using Disposable Syringes
Maximum Infusion Rate	2300.00mL/h

### 5.2. Main Performance

Infusion Rate range	2/3 mL syringe: 0.01 ~ 100.00 mL/h; 5 mL syringe: 0.01 ~ 150.00 mL/h; 10 mL syringe: 0.01 ~ 400.00 mL/h; 20 mL syringe: 0.01 ~ 600.00 mL/h; 30 mL syringe: 0.01 ~ 1000.00 mL/h; 50/60 mL syringe: 0.01 ~ 2300.00 mL/h; resolution is 0.01 mL/h.
VTBI range	0 ~ 9999.99 mL with resolution of 0.01 mL
Infusion accuracy	±1.5%
Purge Rate / Bolus Rate	2/3 mL syringe: 1 ~ 100 mL/h; 5 mL syringe: 1 ~ 150 mL/h;

	<p>10 mL syringe: 1 ~ 400 mL/h;                  20 mL syringe: 1 ~ 600 mL/h;                  30 mL syringe: 1 ~ 1000 mL/h;                  50/60 mL syringe: 1 ~ 2300 mL/h;                  resolution is 1 mL/h.</p>
<p>Purge VTBI /                  Bolus VTBI</p>	<p>0.10mL ~ 50.00mL with resolution of 0.01 mL</p>
<p>KVO Rate</p>	<p>This syringe pump provides two KVO modes to ensure venous patency while guaranteeing infusion safety:</p> <p><b>1.Constant KVO Mode</b> (<math>V_{KVO}</math> rate setting range: 0.10-5.00 mL/h, minimum step value 0.01 mL/h)</p> <p>-When the infusion rate is <math>&gt;V_{KVO}</math> : After the infusion task is completed, the pump automatically runs at the <math>V_{KVO}</math> rate to maintain venous patency.</p> <p>-When the infusion rate is <math>\leq V_{KVO}</math>: After the infusion task is completed, the pump continues to run at the infusion rate to maintain venous patency.</p> <p><b>2.Variable Speed KVO Mode</b> (<math>V_{KVO}</math> rate setting range: 0.10-5.00 mL/h, minimum step value 0.01 mL/h)</p> <p>Users need to set the <math>V_{KVO}</math> rate separately for three scenarios:</p> <p>(a) <math>V_{KVO}(&gt;10)</math> rate for infusion rates <math>&gt; 10</math> mL/h,                  (b) <math>V_{KVO}(1-10)</math> rate for infusion rates between 1-10</p>

	<p>mL/h, and</p> <p>(c) <math>V_{KVO}(\leq 1)</math> rate for infusion rates <math>\leq 1</math> mL/h.</p> <p>The system will automatically matches the KVO rate based on the infusion rate:</p> <p>-When the infusion rate is <math>&gt; 10</math> mL/h: After the infusion task is completed, the pump automatically runs at the <math>V_{KVO}(&gt;10)</math> rate to maintain venous patency.</p> <p>-When the infusion rate is between 1-10 mL/h: After the infusion task is completed, the pump automatically runs at the <math>V_{KVO}(1-10)</math> rate to maintain venous patency.</p> <p>-When the infusion rate is <math>\leq 1</math> mL/h and the infusion rate is <math>&gt; V_{KVO}(\leq 1)</math> rate: After the infusion task is completed, the pump continues to run at the <math>V_{KVO}(\leq 1)</math> rate to maintain venous patency.</p> <p>-When the infusion rate is <math>\leq 1</math> mL/h and the infusion rate is <math>\leq V_{KVO}(\leq 1)</math> rate: After the infusion task is completed, the pump continues to run at the infusion rate to maintain venous patency.</p>
<p>Infusion Time range</p>	<p>00:00:00~99:59:59, with resolution of 1 s.</p>
<p>Occlusion threshold</p>	<p>There are 11 levels, with the lowest being 50mmHg (6.67kPa), and the highest being 1000mmHg</p>

	(133.3kPa), with resolution of 1mmHg.
Maximum infusion pressure generated by the device	1050mmHg
Occlusion alarm trigger time and Bolus dosage	<p>When operated at minimum Infusion rate: &lt; 1 h when the occlusion alarm pressure threshold is set to the lowest pressure; or &lt; 3 h 30 min when the occlusion alarm pressure threshold is set to the highest pressure.</p> <p>When operated at intermediate speed: &lt; 15 min when occlusion alarm pressure threshold is set to the lowest pressure, and the Bolus produced during occlusion is &lt; 0.20 mL; &lt; 45 min, when the occlusion alarm pressure threshold is set to the highest pressure, the Bolus during occlusion is not more than 0.50 mL.</p> <p>(Tested when an occlusion was created 1 meter away from the syringe outlet)</p>
Syringe brand	6 brands of syringes are recommended, including Kangjin, Wego, Kindly, BD, Shinva, B.Braun. 10 brands can be user-defined.
Supported Infusion modes	9 modes, RVT mode, Drug Library mode, Loading Dose mode, Micro mode, Dose mode, RTM mode, Sequence mode, Intermittent mode, Relay mode.

Syringe sizes	2/3mL, 5mL, 10mL, 20mL, 30mL, 50/60mL
Battery running time at intermediate speed	When fully charged, the battery can run continuously for 8h10min in maximum rate(2300.00mL/h).
Alarm Mute Time	2min ± 10s
Call Back Time	1min~60min ± 10s
Classification	Type II CF continuous operating volumetric syringe pump with internal power supply; Grade IP24.
Ambient temperature and humidity	Ambient temperature of transportation and storage: -20 °C ~ + 55 °C Ambient temperature for operation: 5°C ~ + 40 °C Ambient humidity for transportation, storage and operation: 20% ~ 90% Ambient pressure for transportation, storage and operation: 700hPa ~ 1060hPa
Software version	MS39 CC_V1
Service lifetime	8 years

**5.3. Main Functions and Common Functions**

- 1) Automatic identification for syringe specifications
- 2) Set Infusion Rate, VTBI, Infusion Time and real-time data display function
- 3) Displays the function of remaining infusion volume and remaining infusion time
- 4) Purge / Bolus

- 5) Alarms
- 6) The Infusion rate will be automatically changed to KVO Rate after the VTBI complete alarm is activated
- 7) Temporary mute for alarm sound and timer for alarm sound recovery
- 8) Displays the accumulated quantity infusion and supports clearance
- 9) A variety of brands for syringes are supported
- 10) Built-in battery, Displays the remaining battery power
- 11) External power adapter
- 12) Contains Dose-Error Reduction Software
- 13) Electric Drive head

## 6. Structure and Operation Interface

### 6.1. Structural Composition

The structure of the device consists of a pump casing, a motor drive system, an input system, a storage system, a control system, a display system, a sensing and monitoring system, an alarm system and a power supply system.

Names for parts and components:

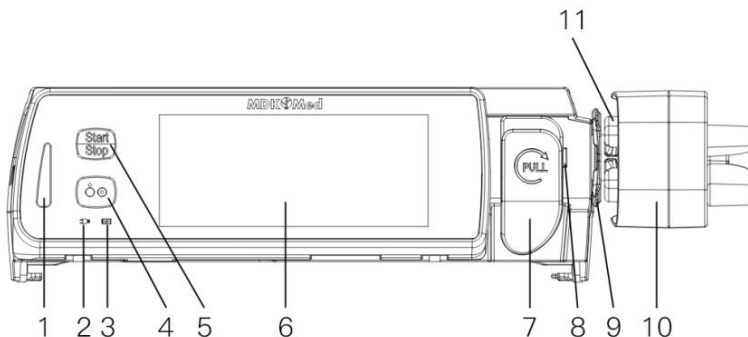

Figure 6-1-1 Front view

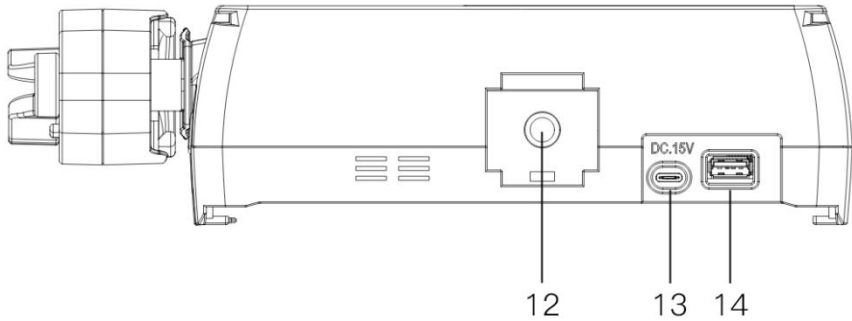

Figure 6-1-2 Rear view

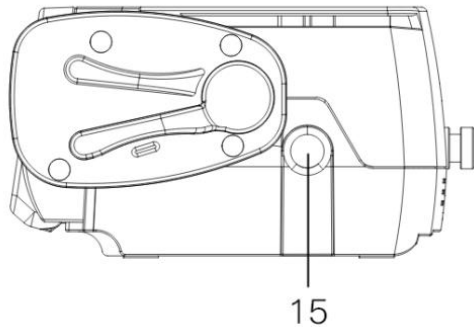

Figure 6-1-3 Side view

1	Operation status indicator	9	Syringe pressure plate
2	External power indicator	10	Push hand seat
3	Charging indicator	11	Swinging arm
4	Power On/Off key	12	Locking screw
5	Start-Stop key	13	Power interface
6	Touch screen display	14	Data Communication port
7	Syringe clamp	15	Stack slot
8	Syringe in-place detection		

## 6.2. Display and Operation Interface

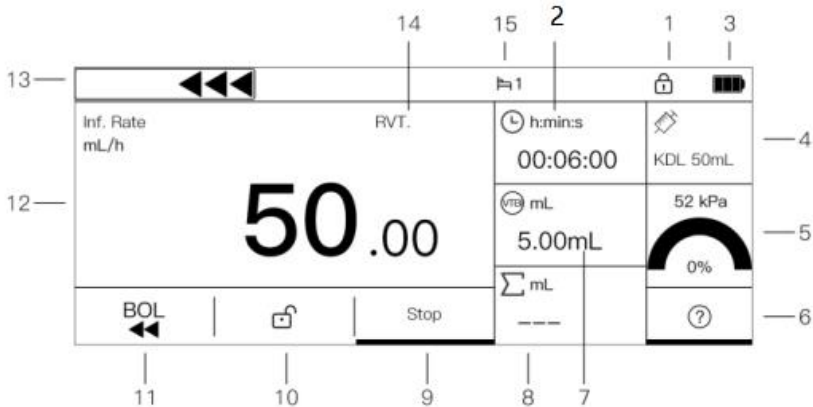

Figure 6-2 Operation interface on the screen

1	Lock screen	9	More information
2	Time remaining	10	Unlock
3	Battery	11	Purge/Bolus
4	Brand	12	Rate
5	Occlusion pressure	13	Infusion stater
6	Start/Stop button	14	Infusion mode
7	Remaining volume	15	Bed number
8	Infused volume		

## 7. Operation Instructions

Install syringe pump → Power on → Device safety self-test → Install syringe → Select syringe brand → Parameters setting → Prime / Purge → Start infusion → Infusion completed → Remove accessories → Power off.

Before infusion starts, please confirm that the syringe in use

matches the current syringe setting selected in the menu. The brand of syringe used in this device for the first time must be calibrated before being used.

## **7.1. Installation of Syringe Pump**

First loosen the locking screw, install the clamp to the pole of the infusion stand, adjust the height of the clamp, and then tighten the locking screw. The operator must make sure that the syringe pump is positioned in a secure, stable and reliable manner.

## **7.2. Power on and Device Safety Self-test**

### **7.2.1. Power on and off**

Before connecting to the mains power, check if there is any foreign matter inside the power outlets (such as drug solution residue).

Connect to the mains power, check the power indicator on the pump front panel. If the indicator is not lit up, check the connection of power cable and the pump, or check if there is a power outage. Then press the power Key on the front panel to turn the device on.

After infusion therapy is completed, press the power key and click Power-Off button to turn the device off. Do not power off when the device is in operation mode, otherwise the infusion therapy will be stopped.

Please remove the syringe before turning the device off.

### **7.2.2. Device safety self-test**

The pump will perform an automatic safety self-test after powered on, if the test is passed then there will be two short beeps and the operation status indicator will be lit up in stable green color. If a continuous alarming sound is initiated or there is no any sound at all,

then the device cannot be used, please contact the customer service immediately.

### **7.3. Quick Use Guide**

#### **7.3.1. Install / Replace syringe**

After the device is power on, the electric drive head will automatically move to the far right to facilitate the next step of loading the syringe.

Open the syringe pump door, pull the syringe clamp out and turn it clockwise for 90° to the horizontal position, place the syringe barrel flange in the slot between the pump casing and the syringe press plate, pull the syringe clamp out again and turn it counterclockwise for 90° to the upright position, release it to clamp the syringe tight in position; straighten the syringe extension line, place it inside the hook behind the pump door to prevent it from being pressed, then close the pump door. When the device detects that the syringe clamp pressed the syringe, the drive head automatically moves from right to left to the place where the syringe presses the hand.

As disposables, syringes must be replaced after being used for once.

When replacing the syringe, the device should be in the stopped state. Pinch and hold the finger grips on the drive head, slide it to the right and release the finger grips, pull the syringe clamp out and rotate it 90° clockwise, remove the syringe and the extension line.

#### **7.3.2. Select syringe**

After the syringe pump is powered on and the safety self-test is passed, Syringe specifications will be monitored continuously. When

the syringe is properly installed, the syringe brand confirmation page will be entered. The brand and model of the syringe will be identified and displayed on the screen. You can also click the Brand button in the upper right corner to enter the syringe brand selection page.

After clicking a syringe to make a selection, the system will automatically return to the parameter setting page. Please check if the syringe displayed on the right side of the screen matches the set that is being used.

It is possible that the syringes from the same brand may have different characteristics if they are from different lots, which will affect their infusion accuracy if they are not calibrated before use. In that case, calibration of the syringe is recommended, which is described in Section 10.2 Accuracy Calibration for Syringes.

Syringe Brands		
KDL 30 mL		▲
		—
		▼
		↶

Figure 7-3-2 Syringe brand confirmation

### 7.3.3. Set infusion parameters

**General method:**

When the syringe pump is standby, click "☑" on the touch screen to enter the RVT mode parameter setting interface. Click "Inf. rate" on the touch screen, a numeric button board appears on the screen, click

to enter the value of the Infusion rate to be set, and press "√" on the screen to complete the input.

Setting the VTBI and infusion time is the same as setting the infusion rate above. After all parameters are set, click the "√" button to confirm the parameters.

**Quick setting method:**

When the syringe pump is standby, click "Inf. rate" value on the screen, and a numeric button board appears. Click to enter the value of the Infusion rate to be set, and press "√" on the screen to complete the input.

RVT.			
Inf. Rate	---	mL/h	✓
VTBI	---	mL	
Inf. Time	--:--:--	H:M:S	
			↶

Figure 7-3-3-1 Set infusion parameters

1	2	3	⌫
4	5	6	↶
7	8	9	✓
.	C	0	

Figure 7-3-3-2 Input values using keypad

### 7.3.4. Purge

When the pump is standby, confirm that the tube is disconnected from the patient. Click the Bolus button, the device pops up “Please disconnect tube!”, after clicking “√” on the touch screen, the device will run at the Purge rate and Purge VTBI set by the system, quickly purge the air in the infusion pipeline. Press the start/stop key or click the pause button can stop purging. Repeat until there are no bubbles.

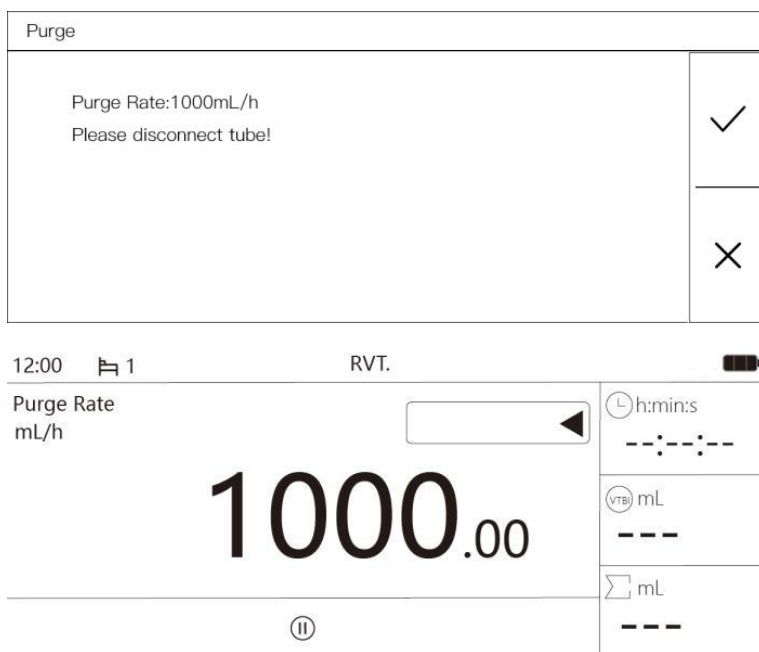

Figure 7-3-4 Purge syringe

The purge volume is not included in the Infusion accumulation.

### 7.3.5. Start infusion

Press the Start/Stop key or click the start button and the pump will start to run according to the set infusion parameters, as shown in the following figure.

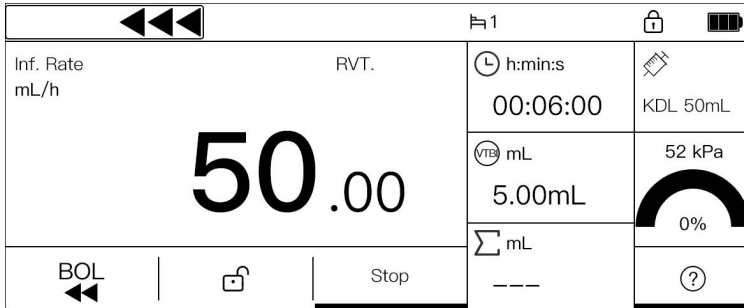

Figure 7-3-5 Infusion operation interface

### 7.3.6. Infusion completed

The infusion is completed when the infusion accumulation volume reaches the VTBI set for the infusion task.

If KVO is enabled, the device will convert to the KVO Rate to continue running automatically and trigger the "Enter KVO" high priority alarm at the same time, make an alarm sound. Click the "√" on the screen to exit the KVO infusion status.

If KVO is disabled, the device will trigger the "End Of Infusion" alarm, accompanied by an high priority alarm sound. Click the "√" on the touch screen eliminates alarm.

After the infusion is completed, remove the infusion accessories that are no longer used following the steps described in Section 7.3.1. Press the power on/off key, click power-off button to turn off the device. Pull the ring on the base of the mounting clamp upward and pull the syringe pump body outward to remove it.

### 7.4. Pause or Stop Infusion

Infusion normal operation status see Figure 7-3-5.

Press the Start/Stop key during infusion operation can pause the operation, as shown in the following figure.

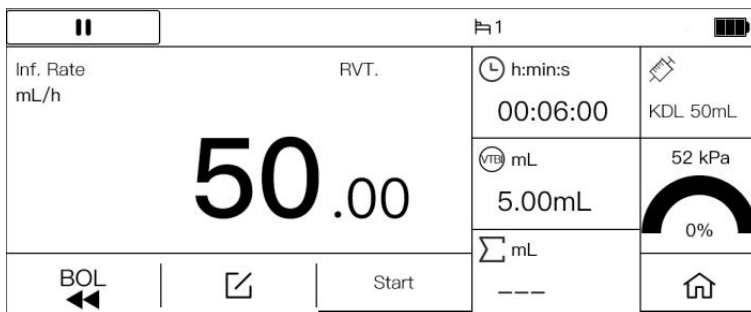

Figure 7-4 Infusion pause

On the Infusion pause page, press the Start/Stop key again can start the device operation, and the device will continue to infuse the remaining volume based on the set Infusion rate.

During the infusion pause, any parameter of the Infusion rate, VTBI, and Infusion time is modified will be considered a new infusion task, and when press the Start/Stop key again, the infusion task will be completed according to the new infusion parameters.

When the device triggers the alarm, makes an alarm sound, presses the "Mute" button on the screen can pause the alarm sound, and after 2 minutes, if the alarm source is not lifted, the alarm sound is automatically restored.

## 7.5. Bolus

### 7.5.1. Hand off bolus

In the infusion operation state, click the "BOL" button, enter the Hand Off Bolus page, set the bolus parameters, click the "√" button, the syringe pump enter into bolus infusion state until the bolus VTBI is completed, the syringe pump returns to the normal infusion state continue the infusion, the bolus volume is included in the infusion accumulative volume.

Hand Off Bolus			
Bolus Rate	---	mL/h	✓
Bolus VTBI	---	mL	
Bolus Time	--:--:--	H:M:S	
			↶

Figure 7-5-1-1 Bolus Settings interface

12:00	1	RVT.	🔋
Bolus Rate mL/h	<input type="text" value="2000.00"/>		⌚ h:min:s 00:00:09
			Ⓜ mL 5.00
	⏸		∑ mL ---

Figure 7-5-1-2 Bolus running interface

## 7.6. Lock and Unlock Screen Function

The device automatically locks the screen after running for a period of time. When the device is in the lock screen, click the screen and a prompt will pop up asking whether to unlock the screen, click the "✓" button to unlock the screen.

Auto Lock time settings See Home - Setting - Auto Screen Lock.

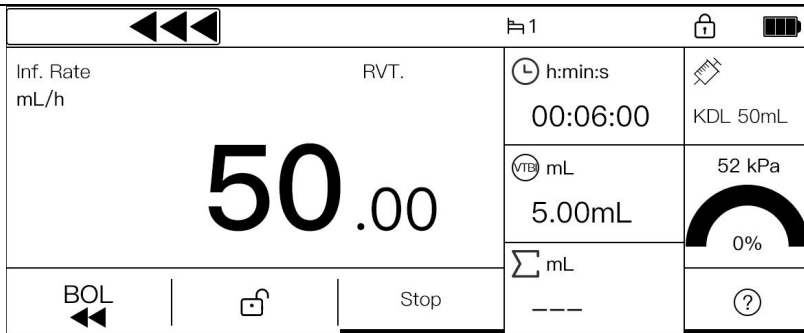

Figure 7-6 Lock Screen

### 7.7. Infusion Mode Selection and Setting

Except for the RVT mode on the home screen, there are 8 infusion modes on the Infusion Mode page: Dose mode, Drug Library mode, RTM mode, Sequence mode, Loading Dose mode, Intermittent mode, Micro mode, Relay mode.

Inf. Mode		1/2
RVT.	Drug Library	^
Loading Dose	Micro	v
Dose	TPN.	↶
Sequence	Intermittent	↷

Figure 7-7 Infusion Mode

In the RVT setting page, the infusion rate, VTBI and infusion time can be set in a variety of combinations, forming the following four combinations of infusion mode: rate + volume (R+V) Mode , rate + time (R+T) Mode, volume + time (V+T) Mode, rate (R) Mode. Therefore, there are 11 different infusion modes for the device in total.

The setting of the RVT mode should follow the instructions in the 7.3 "Quick Use Guide" above. The settings for the other modes are outlined below.

**7.7.1. Dose mode**

Enter the Dose mode settings interface, as shown in Figure 7-7-1. After setting the Dose, Solution, Concentration, Dose Rate, Weight, VTBI and Infusion Rate, click "√" to confirm the parameters.

In the main interface of Dose mode, click the "unit" in the upper left corner to switch the display of "Dose Rate" and "Infusion rate".

Dose		1/2	
Dose	---	mg	✓
Solution	---	mL	^
Conc.	---	mg/mL	∨
Dose Rate	---	mg/kg/h	↶
Dose		2/2	
Weight	---	mg	✓
VTBI	---	mL	^
Inf. Rate	---	mL/h	∨
			↶

Figure 7-7-1 Dose mode setting

In the Dose Mode Settings interface, click "Unit" to the right of any parameter in "Dose", "Concentration" and "Dose Rate" to select different unit expression modes, and the other two corresponding units

will be automatically adjusted.

Concentration and Infusion Rate are calculated as follows:

Concentration calculation formula:

$$\text{Concentration(mg/mL)} = \frac{\text{Dose (mg)}}{\text{Solution (mL)}}$$

Infusion rate calculation formula:

Infusion Rate(mL/h)

$$= \frac{\text{Dose Rate (mg/kg/h)} \times \text{weight (kg)} \times \text{Solution (ml)}}{\text{Dose (mg)}}$$

$$\text{Infusion Rate(mL/h)} = \frac{\text{Dose Rate (mg/h)} \times \text{Solution (ml)}}{\text{Dose (mg)}}$$

### 7.7.2. Drug Library mode

Enter the drug library mode settings interface.

Select the name and the specific specifications of the drug that requires infusion. The device will enter the drug library mode settings page and automatically brings in the drug-related parameters. At this point, the drug name and drug specifications are displayed in the title bar of the parameter settings page. After setting the parameters, click "√" to confirm the parameters.

ADREnaline		1/2	
Conc.	---	mg/mL	✓
Weight	---	Kg	^
Dose Rate	---:---	mg/Kg/mL	∨
Inf. Rate	---	mL/h	↶

ADREneline		2/2	
VTBI	---	mL	✓
			^
			v
			↶

Figure 7-7-2 Drug library mode setting

The Drug library mode has built-in DERS (Dose-error Reduction Software) functionality to reduce medication errors and improve infusion safety.

**7.7.3. RTM mode**

Enter the RTM mode(Ramp and Taper Mode) settings interface, as shown in Figure 7-7-3.

RTM.		1/2	
Inf. Time	--:--:--	H:M:S	✓
Rising Time	--:--:--	H:M:S	^
Falling Time	--:--:--	H:M:S	v
VTBI	---	mL	↶

RTM.		2/2	
Steady Rate	---	mL/h	✓
			^
			v
			↶

Figure 7-7-3 RTM mode setting

In the RTM mode parameters, VTBI, Up Time, and Down Time must be set. After setting one of the two parameters of Plateau rate or Total Time, the other parameter will be calculated automatically. After setting the parameters, click "√" to confirm the parameters.

When the device is started, the infusion rate gradually increases from 0 to Plateau Rate during the Up Time and then maintains the rate. When the remaining time is equal to the Down Time, the infusion rate gradually decreases until it reaches 0 and the infusion is completed.

**7.7.4. Sequence Mode**

Enter the Sequence Mode settings interface to set the number of sequences (up to 10 groups), click the "√" button to enter the infusion parameter settings interface, as shown below.

Sequence		1/3
Seq. Count	1	√
		^
		v
		↶

Sequence		2/3
S1-Inf. VTBI	--- mL	√
S1-Inf. Time	--:--:-- H:M:S	^
S1-Inf. Rate	--- mL/h	v
		↶

Sequence		3/3	
Total VTBI	---	mL	✓
Inf. Time	--:--:--	H:M:S	^
			∨
			↶

**Figure 7-7-4 Sequence Mode Setting**

As shown in the figure, Set any two of the Infusion VTBI, Infusion Rate, Infusion Time, the device will automatically calculate another parameter.

After setting infusion parameters for all sequences according to clinical needs, click "√" to confirm the parameters.

When the device completes the infusion parameters of the first sequence, it automatically switched to the parameter run of the second sequence until the set parameters of all sequences were completed and the infusion is completed.

**7.7.5. Loading Dose Mode**

Enter the Loading Dose mode settings interface.

Loading Dose		1/2	
VTBI	---	mL	✓
Loading VTBI	---	mL	^
Loading Rate	---	mL/h	∨
Maintain Rate	---	mL/h	↶

Loading Dose		2/2	
Loading Time	--:--:--	H:M:S	✓
Maintain Time	--:--:--	H:M:S	^
			∨
			↶

Figure 7-7-5 Loading Dose mode setting

As shown in the figure, After setting the VTBI, Loading VTBI, Loading Rate, and Maintain Rate, the device automatically calculated the Loading Time and Maintain Time, and click the "✓" button to confirm the infusion parameters.

**7.7.6. Intermittent mode**

Intermittent			
Single VTBI	---	mL	✓
Single Rate	---	mL/h	
Inter Time	--:--:--	H:M:S	
Maintain Rate	---	mL/h	↶

Figure 7-7-6 Intermittent mode

Enter intermittent mode settings interface.

As shown in the figure, set the Single VTBI, Single Rate, Intermittent Time and Maintain Rate, and click the "✓" button to confirm the infusion parameters. After the device is started, the infusion will start at the Single Rate. When the infused volume is equal to the single VTBI, the device will automatically continue infusion according to the

Maintain Rate. When the Maintain Rate is set to 0, the device will run at 0mL/h. The device runs at Maintain Rate until the time is equal to the Intermittent Time, the device automatically switches to the Single Rate to continue the infusion, so as to cycle.

**7.7.7. Micro mode**

Enter Micro mode settings interface.

Set any two of the Infusion Rate, VTBI, and Infusion Time, the device will automatically calculate another parameter. The Infusion Rate should not exceed 100mL/h. After the device is started, the infusion starts at the Infusion Rate. When the infused volume is equal to the VTBI, the infusion will be stopped automatically.

When only sets the Infusion Rate, the device runs at the Infusion Rate until the operator stops the infusion or the device triggers a high priority alarm to stop the infusion.

**7.7.8. Relay mode**

The Syringe Pumps can be installed on our infusion workstation for advanced application functions such as relay infusion and drug library management through the Infusion Information Collection System.

**7.8. View Log**

On the Home - Event Log Page, event logs such as device infusion status and alarm can be displayed. Click this event can view the detailed event information such as Infusion Rate, VTBI, time, Alarm priority and time.

When the pump log store reaches the upper limit of the pump capacity, the oldest log will be overwritten by the new log.

Through the infusion workstation, all infusion and alarm log information can be stored and queried in unlimited, and the log information can be printed out on the Internet to facilitate the needs of medical management.

When the alarm system is powered off, the log still exists.

EventLog		1/3	
Low Battery	2020-01-01	>	^
Call Back Alarm	2020-01-01	>	v
Low Battery	2020-01-01	>	↶
Low Battery	2020-01-01	>	↷

Figure 7-8-1 Event Log

No AC Power	
Time	01-24 ---:--:--
Alarm priority	Low priority alarm
↷	

Figure 7-8-2 Alarm priority

## 8. Alarms

Alarm refers to the infusion changes caused by the abnormal infusion circuit or the failure of the syringe pump itself, which leads to the failure of the infusion to the patient. The syringe pump prompts the medical staff through sound, light, screen signs and other ways.

Alarm classification prompts of the device:

<b>No.</b>	<b>Alarm</b>	<b>Priority</b>	<b>Alarm category</b>	<b>Alarm conditions</b>
8.1	No syringe	High	Latching	1. Syringe fall off . 2. The syringe rear barrel ear is not mounted between the syringe pump housing and the syringe pressure plate.
8.2	OCCL (Occlusion)	High	Latching	When the infusion line is occluded.
8.3	Empty Of Syringe	High	Latching	When the syringe is pushed to the end.
8.4	End Of Infusion	High	Latching	When the infused volume is equal to the VTBI.
8.5	Pusher Setup Fail	High	Latching	When pump is running, the syringe push handle without touch the pressure conduction block.
8.6	Battery Empty	High	Latching	When the internal battery is running out.
8.7	Battery&Exte rnal Power Disconnect	High	Unlatching	When the device is running, the battery and external power is disconnected at the same time.
8.8	Motor Err.	High	Latching	In the event of a motor failure.
8.9	Pusher Position	High	Latching	The infused volume exceeded the expected

	Error			volume during the machine is running.
8.10	Battery Error	High	Latching	The device does not detect battery signal or battery disconnect when plug in the external power.
8.11	KVO	High	Latching	The infusion is complete with KVO is enabled.
8.12	KVO End	High	Latching	KVO status run for 30 minutes until the KVO task is complete.
8.13	Standby End	High	Latching	When standby is end.
8.14	Com. Err. (Communication error)	High	Latching	Monitor the CPU for communication handshake errors.
8.15	Call Back	Low	Unlatching	The device is ready to start the infusion, but the device is not started and the device is placed without operation for the set time.
8.16	Low battery	Low	Unlatching	When the internal battery power is low.
8.17	Near End Of Infusion	Low	Unlatching	When the remaining time is less than or equal to the set near end of infusion time.
8.18	Near Empty Of Syringe	Low	Unlatching	The remaining volume of the syringe is less than 10% or

				the time from emptying is less than 3 minutes.
8.19	No AC Power	Low	Unlatching	When the device is disconnected from the external power and operated with batteries.

**The device alarm indicator characteristics:**

Alarm priority	Indicator color	Flicker frequency		Rate
High priority	Red	2Hz	0.7Hz (Battery & External Power Disconnect)	50%
Medium priority	/	/		/
Low priority	Yellow	Normally turned on		100%

High-priority and low-priority alarms are distinguished in sound and light according to standard requirements. When an alarm occurs, the operator can accurately detect it at 1m away from the alarm system. The delay time of triggering the alarm signal is not more than 2s.

After powering on, the status indicator lights up, and the device automatically conducts a safety check. After passing the self-check, you will hear two short beeps of "DiDi", which means that the alarm system is normal. If the status indicator does not light up or you hear a continuous alarm sound or no prompt sound after booting, it means that the alarm system is faulty and the device cannot be used normally. It can be put into use after being repaired.

The sound pressure range of the audible alarm signal is 60-95dB.

Note that this device prohibits access to the change or storage change alarm function. In the process of adjusting the alarm limit or alarm preset, the operation of the alarm system still runs according to the last setting. This device alarm is a technical alarm state.

=====



Latching alarm signal: The alarm signal that continues to be generated after the trigger event no longer exists, and does not stop until the operator deliberately acts (click the "√" button);

Unlatching alarm signal: When the related trigger event is no longer When it exists, automatically stop the alarm signal generated.

Device alarm announcement sequence:

High priority alarm sound priority principle, that is, when the device is in the low priority alarm sound state, when a high priority alarm is generated, the original low priority alarm sound is interrupted, the high priority alarm sound is broadcast, and the high priority alarm sound is displayed at the same time Level alarm prompt information.

The device is in a high priority alarm. When a low priority alarm is generated, the high priority alarm continues to broadcast without being interrupted.

The device is in low priority alarm. When a low priority alarm is generated, it still reports a low priority tone and displays the latest alarm prompt information.

The device detects that a visual alarm and an audible alarm appear immediately.

When the power loss time is less than 30 seconds, the alarm settings

before the power loss will automatically restore.

=====

### 8.1. No Syringe Alarm

**Cause:** When the syringe clamp is accidentally pulled open while the device is running, or when the syringe rear clamp is not installed between the syringe pump casing and the stopper plate, the device will trigger an alarm, stop running, make a high priority alarm sound, the screen appear with the message "No syringe" and the operation status indicator flash red at the same time.

**Solution:** Click the "✓" button on the screen to clear the alarm, the message " No syringe " disappears, and returns to the infusion pause interface. Check the syringe clamp and reinstall the syringe to continue using.



Figure 8-1 No Syringe Alarm

### 8.2. Occlusion Alarm

**Cause:** When the infusion line is occluded, occlusion sensor detects that it is exceeding the set value, the device will trigger an alarm, stop running, make a high priority alarm sound, the screen appear with the message "OCCL" and the operation status indicator flash red at the same time.

At the same time, as a infusion safety protection mechanism, the

motor reverses back to pump a small amount of liquid medicine to reduce the dose of the bolus before occlusion relief.

**Solution:**

- 1) Click the "√" button on the screen to clear the alarm and the message "OCCL " disappear.
- 2) Check whether the syringe extension line is kinked, whether the patient presses into the syringe extension line and other issues, eliminate the problem and restart the infusion.
- 3) If there is still an occlusion alarm, remove the syringe, replace the syringe and restart the infusion.

**8.3. Empty Of Syringe Alarm**

**Cause:** When the remaining liquid amount of syringe is 0, the device will trigger an alarm, stop running, make a high priority alarm sound, the screen appear with the message "Empty Of Syringe" and the operation status indicator flash red at the same time.

**Solution:** Click the "√" button on the screen to clear the alarm and the message " Empty Of Syringe " disappears. After reinstalling a new syringe with enough of the same drug, press the Start/Stop key or click the start button to complete the remaining infusion tasks.

**8.4. End Of Infusion Alarm**

**Cause:** If KVO is disabled, When the infused volume reaches the VTBI, the device will trigger an alarm, stop running, make a high priority alarm sound, the screen appear with the message "End Of Infusion" and the operation status indicator flash red at the same time.

As a infusion security mechanism, If KVO is enabled, the device will automatically convert to KVO Rate to continue the infusion.

**Solution:** Click the "√" button on the screen to clear the alarm and the message "End of Infusion" disappears. The device can be set up and used again.

### 8.5. Pusher Setup Fail Alarm

**Cause:** When the syringe pump is running, the finger grips of the drive head was accidentally pinched and pulled out, result in the syringe push handle without touch the pressure conduction block, the device will trigger an alarm, stop running, make a high priority alarm sound, the screen appear with the message "Pusher Setup Fail" and the operation status indicator flash red at the same time.

**Solution:** Click the "√" button on the screen to clear the alarm sound and the message " Pusher Setup Fail " disappears. Check the drive head, reinstall the syringe to continue using.

### 8.6. Battery Empty Alarm

**Cause:** When the internal battery is running out, the device will trigger an alarm, stop running, make a high priority alarm sound, the screen appear with the message "Battery Empty" and the operation status indicator flash red at the same time, and the device will stop running and power off after 3 minutes.

**Solution:** The external power supply should be used immediately. When plugged in the external power supply, the battery charge light goes on and the battery starts charging. When the battery is fully charged, the battery charge indicator goes out.

### 8.7. Battery & External Power Disconnect Alarm

**Cause:** When the syringe pump is running, the external power is disconnected, and the device does not detect the battery signal or the

battery is disconnected unexpectedly, the device will trigger an alarm, the screen is black, the operation status indicator flash red at the same time, and the sound and light continue to alarm for 3 minutes before the device automatically power off.

**Solution:** Use external power supply or battery supply, and restart the device after power supply.

### 8.8. Motor Error Alarm

**Cause:** When an error is detected in the motor feedback signal (too slow or too fast, or wrong direction of motor operation etc.), or the sensor detection of push handle position does not match the cumulative amount of infusion, the device will trigger an alarm, stop running, make a high priority alarm sound, the screen appear with the message "Motor Error" and the operation status indicator flash red at the same time.

**Solution:** Click the "√" button on the screen to clear the alarm. Start the infusion again, still report the fault alarm, please contact our service personnel.

### 8.9. Pusher Position Error Alarm

**Cause:** When the syringe pump is running, the infused volume exceeded the expected volume, the device will trigger an alarm, stop running, make a high priority alarm sound, the screen appear with the message "Pusher Position Error" and the operation status indicator flash red at the same time.

**Solution:** Click "√" button on the screen to clear the alarm sound. Check the drive head and syringe specifications, reinstall the syringe to continue using.

## 8.10. Battery Error Alarm

**Cause:** When the external power is inserted on the device, the device does not detect the battery signal or the battery is disconnected unexpectedly, the device will trigger an alarm, stop running, make a high priority alarm sound, the screen appear with the message "Battery Error" and the operation status indicator flash red at the same time.

**Solution:** Click "√" button on the screen to clear the alarm sound. Press the Power on/off key to shut down the device and restart the device. If the fault alarm is still reported, please contact our service personnel.

## 8.11. KVO Alarm

**Cause:** When KVO is enabled and the infusion is complete, the device will automatically convert to the KVO Rate to continue operation. At the same time, the device will trigger high priority alarm and sound alarm, the screen appear with the message "KVO" and the operation status indicator will flash red at the same time.

**Solution:** Click the "√" button on the screen to clear the alarm. The message "KVO" disappear. The device can be reset according to operating steps.

## 8.12. KVO End Alarm

**Cause:** When the KVO state runs for 30 minutes until KVO task is completed, the device will trigger an alarm, stop running, make a high priority alarm sound, the screen appear with the message "KVO End" and the operation status indicator flash red at the same time.

**Solution:** Click the "√" button on the screen to clear the alarm.

The message "KVO End" disappear. The device can be reset according to operating steps.

### 8.13. Standby End Alarm

**Cause:** When the device is in standby and the standby is over, the device will trigger high priority alarm and sound alarm, the screen appear with the message "Standby End" and the operation status indicator flash red at the same time.

**Solution:** Click the "√" button on the screen to clear the alarm.

### 8.14. Communication Error Alarm

**Cause:** When the communication of the device monitoring CPU is incorrect, the device will trigger an alarm, stop running, make a high priority alarm sound, the screen appear with the message "Communication Error" and the operation status indicator flash red at the same time.

**Solution:** Click "√" button on the screen to clear the alarm sound. Press the Power on/off key to shut down the device and restart the device. If the fault alarm is still reported, please contact our service personnel.

### 8.15. Call Back Alarm

**Cause:** The device is ready to start the infusion, but the device is not started and the device is placed without operation for the set time, the device will trigger an alarm, make a low priority alarm sound, the screen appear with the message "Call Back" and the operation status indicator steady on yellow at the same time.

**Solution:** Click the "√" button on the screen to clear the alarm.

Call Back Alarm



Forget to operate?



Figure 8-15 Call Back Alarm

### 8.16. Low battery Alarm

**Cause:** When the internal battery is low, the device will trigger an alarm, make a low priority alarm sound, the screen appear with the message "Low Battery" and the operation status indicator steady on yellow at the same time. If the syringe pump is infusing, the device will not stop infusing.

**Solution:** The external power supply should be used immediately. When plugged in the external power supply, the battery charge indicator lights up, the battery starts charging, and the message "Low battery" disappears, the battery icon shows the dynamic effect of charging. When the battery is fully charged, the battery charge light goes out.

### 8.17. Near End Of infusion Alarm

**Cause:** When the remaining time is less than or equal to the set near end of infusion time, the device will trigger an alarm, make a low priority alarm sound, the alarm indicator area at the top of the screen appear with the message "Near End Of Infusion" and the operation status indicator steady on yellow at the same time, and the syringe pump continues to infusion does not stop.

**Solution:** Click the "Mute" button on the right of the alarm prompt area to suspend the alarm sound. Focus on the amount of fluid remaining in the syringe pump and the time remaining, and wait for the syringe pump infusion to complete.

### 8.18. Near Empty Of Syringe Alarm

**Cause:** If the device is running at the current Infusion Rate, when the remaining volume of the syringe should be less than 10% or the time from emptying should be less than 3 minutes, the device will trigger an alarm, make a low priority alarm sound, the alarm indicator area at the top of the screen appear with the message "Near Empty Of Syringe" and the operation status indicator steady on yellow at the same time, and the syringe pump continues to infusion without stopping.

**Solution:** Click the "Mute" button on the right of the alarm prompt area to suspend the alarm sound. Focus on the amount of remaining liquid in the syringe and replace the syringe in time.

### 8.19. No AC Power Alarm

**Cause:** When the device is powered on without the network power and use battery power supply, the device will trigger an alarm, make a low priority alarm sound, the screen appear with the message "No AC Power" and the operation status indicator steady on yellow at the same time.

**Solution:** Click the "√" button on the screen or connect to an external power supply to clear the alarm.

## 9. System Parameter setting

### 9.1. Bed number

The Bed number can be set on the Home-Setting- Bed number page.

### 9.2. Brightness

On the Home- Setting- Brightness page, brightness of the display can be adjusted between 1 and 10 level by clicking on the + or – sign. After brightness setting is completed, click the "√" button to return to the previous page.

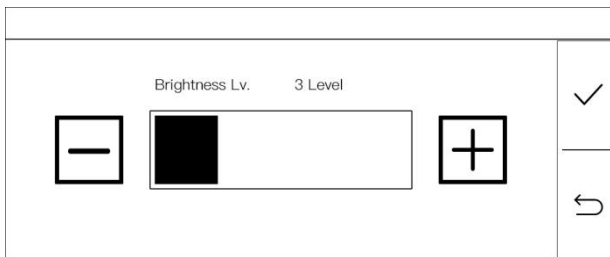

Figure 9-2 Brightness setting

### 9.3. Alarm Sound Volume

On the Home- Setting- Volume- page, alarm sound volume can be adjusted between 1 and 5 level by clicking on the + or – sign. After sound volume setting is completed, click the "√" button to return to the previous page.

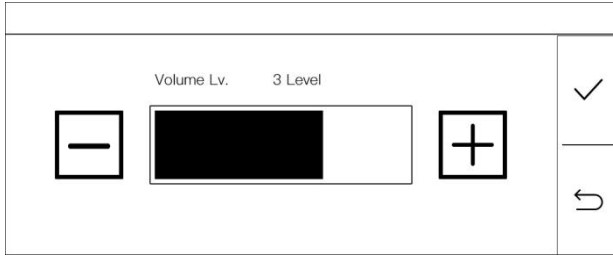

Figure 9-3 Volume setting

#### 9.4. Occlusion Pressure Level

The occlusion pressure Level can be set on the Home- Setting- Level Setting page. Click + or - sign on the screen to choose a pressure level. Click the "✓" button to return to the previous page.

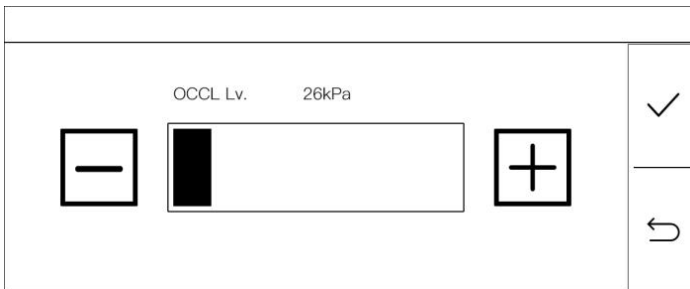

Figure 9-4 Occlusion pressure level setting

Level	OCCL value (mmHg)	OCCL value (kPa)
1	50	6.67
2	100	13.33
3	200	26.67
4	300	40
5	400	53.33
6	500	66.67
7	600	80
8	700	93.33

9	800	106.67
10	900	120
11	1000	133.33

The occlusion alarm accuracy is  $\leq 5\text{mmHg}$ .

**9.5. Bolus Setting**

The Bolus Rate and Bolus VTBI can be set on the Home- Setting- Bolus page. Click the corresponding parameter value to set. After the Settings are complete, click the Back button to return to the previous page.

**9.6. Purge Setting**

The Purge Rate and Purge VTBI can be set on the Home- Setting- Purge page. Click the corresponding parameter value to set. The values set in the Purge setting will not affect the Bolus Rate and Bolus VTBI.

**9.7. Call Back Time Setting**

On the Home- Setting- Call Back Time page, can set the Call Back Alarm time when the device is placed without operation and not running.

**9.8. KVO setting**

On the Home- Setting - KVO page, set the KVO Mode and KVO Rate after the End Of Infusion.

Select the Constant KVO mode and the device will operate according to the currently set KVO Rate.

Select the Adaptive KVO mode, the device will automatically determine the KVO Rate level according to the current Infusion rate

of the infusion operation, and run according to the KVO Rate of the currently set Infusion rate level.

**Constant KVO Mode** ( $V_{KVO}$  rate setting range: 0.10-5.00 mL/h, minimum step value 0.01 mL/h)

-When the infusion rate is  $>V_{KVO}$ : After the infusion task is completed, the pump automatically runs at the  $V_{KVO}$  rate to maintain venous patency.

-When the infusion rate is  $\leq V_{KVO}$ : After the infusion task is completed, the pump continues to run at the infusion rate to maintain venous patency.

**Variable Speed KVO Mode** ( $V_{KVO}$  rate setting range: 0.10-5.00 mL/h, minimum step value 0.01 mL/h)

Users need to set the  $V_{KVO}$  rate separately for three scenarios:

- (a)  $V_{KVO}(>10)$  rate for infusion rates  $> 10$  mL/h,
- (b)  $V_{KVO}(1-10)$  rate for infusion rates between 1-10 mL/h, and
- (c)  $V_{KVO}(\leq 1)$  rate for infusion rates  $\leq 1$  mL/h.

The system will automatically matches the KVO rate based on the infusion rate:

-When the infusion rate is  $> 10$  mL/h: After the infusion task is completed, the pump automatically runs at the  $V_{KVO}(>10)$  rate to maintain venous patency.

-When the infusion rate is between 1-10 mL/h: After the infusion task is completed, the pump automatically runs at the  $V_{KVO}(1-10)$  rate to maintain venous patency.

-When the infusion rate is  $\leq 1$  mL/h and the infusion rate is  $> V_{KVO}(\leq 1)$  rate: After the infusion task is completed, the pump continues to run at the  $V_{KVO}(\leq 1)$  rate to maintain venous patency.

-When the infusion rate is  $\leq 1$  mL/h and the infusion rate is  $\leq V_{KVO}(\leq 1)$  rate: After the infusion task is completed, the pump continues to run at the infusion rate to maintain venous patency.

### **9.9. Auto Screen Lock Time**

On the Home- Setting- Auto Screen Lock page, set the Lock time for the screen and keys of the device during infusion operation.

If the screen lock time is set to 0, the Auto Screen Lock function is disabled.

You can also manually lock the device by clicking the "Lock screen" button on the screen when the device infusion is running. When the screen is locked, click the "Unlock" button on the screen to unlock it. When the screen is locked, other buttons and screen areas are unavailable except the power button and the Unlock button on the screen.

### **9.10. Near End Of Infusion Time Setting**

The near end of infusion time can be set on the Home- Setting- NEOI page.

### **9.11. Prime prompt switch**

On the Home- Setting- Prime prompt switch page, can choose whether to enable the Prime prompt, if this function is enabled, the "Prime" prompt page will appear when a new infusion task starts after each syringe change.

### **9.12. Night mode Setting**

On the Setting- Maintenance- Night Mode page, can set the brightness or sound volume for daytime or nighttime, the setting

method is the same as that for brightness and sound level.

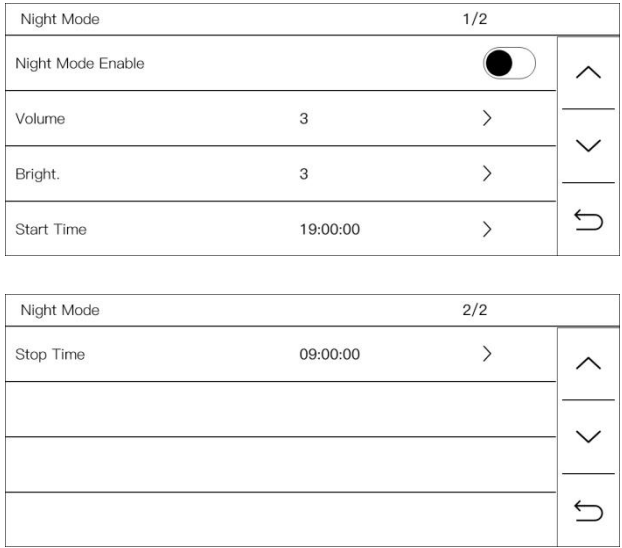

Figure 9-12 Night mode setting

### 9.13. Date/Time Setting

The device of Time and date can be set on the Setting - Maintenance- Date/Time page.

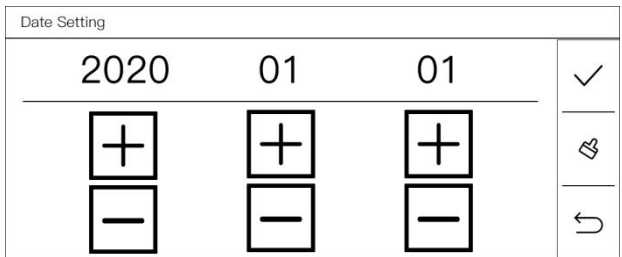

Figure 9-13-1 Date Setting

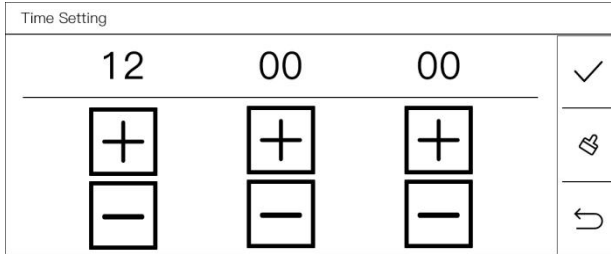

Figure 9-13-2 Time Setting

### 9.14. History mode switch

On the Home- Setting- History mode switch page, can choose whether to enable the History mode, if this function is enabled, the "Sure to load last treatment?" prompt page will be displayed after each power on.



Figure 9-14 Sure to load last treatment

### 9.15. Syringe brand

When the device is not running, click the syringe brand on the upper right corner of the interface, select the corresponding syringe name, and the device will return to the infusion page. The selected brand for the syringe will be shown on the upper right corner of the infusion page, which can remind the operator to use the right syringe to maintain high infusion accuracy. Below are the compatible syringe brands of the device.

SN	Brand
1	Kangjin
2	Wego
3	Kindly
4	BD
5	Shinva
6	B.Braun

The calibration operation of syringes, see Section 10 Accuracy calibration for Syringe.

**9.16. Maintenance**

Maintain the device in “Setting - Maintenance”, including the calibration of syringe accuracy, system time settings, system language settings, factory resets, etc. Entering the Maintenance interface requires entering the engineer's maintenance password, password please consult the company's sales and service personnel.

Syringe precision calibration operation instructions see Section 10 of this manual.

**10. Accuracy Calibration for syringe**

The brand and specification syringes that have not been calibrated, or syringes belonging to different production lots with the calibrated syringes, need to be calibrated before use. In normal use, the syringe should be re-calibrated every 6 months.

**10.1. Automatic Accuracy Calibration for syringe**

- 1) Pull the empty syringe that needs to be calibrated to the maximum range and install it to the device.

- 2) Click "Home - Setting - Maintenance - Consumables maintenance - Calibration Consumable" to enter the consumables calibration page.
- 3) Click the Brand and select the consumables brand that needs to be calibrated.
- 4) Click the specification and select the specification for this calibration.
- 5) Click Auto Calibration Start/Stop and wait for the device to run until the syringe is pushed empty.
- 6) Turn to the next page and click OK to save the current calibration value.

### **10.2. Manual Accuracy calibration for Syringe**

- 1) Fill the syringe that needs to be calibrated with liquid, connect it to the balance or measuring cylinder through the extension tube, and install it to the device.
- 2) Prime/Purge until the extension tube is filled with liquid and stop.
- 3) Click "Home - Setting - Maintenance - Consumables maintenance - Calibration Consumable" to enter the consumables calibration page.
- 4) Click the brand and select the consumables brand that needs to be calibrated.
- 5) Click the Specification and select the specification for this calibration.
- 6) Pour out the water in the measuring cylinder or clear the balance.
- 7) Click the calibration Start/Stop, the calibration remaining amount will be displayed on the right side, and wait for the remaining amount to displayed.
- 8) Turn to the next page, click the Volume Output, input the actual volume read from the balance or measuring cylinder, click OK, and save the current calibration value.

## 11. Precautions for Using Disposable syringe

It's suggested to use the recommended Syringe. The ambient temperature should be kept at least at 5°C or above when a recommended Syringe is used. The infusion accuracy will be compromised if ambient temperature is lower than 5°C.

The recommended Syringe are listed in the table below:

No.	Brand	Infusion accuracy	Ambient temperature
1	Kangjin	± 1.5%	+5°C ~ +40°C
2	Wego	± 1.5%	+5°C ~ +40°C
3	Kindly	± 1.5%	+5°C ~ +40°C
4	BD	± 1.5%	+5°C ~ +40°C
5	Shinva	± 1.5%	+5°C ~ +40°C
6	B.Braun	± 1.5%	+5°C ~ +40°C

The syringe used must have a medical device product registration certificate, and the syringe specifications are selected in the same specification as the recommended syringe brand. Syringe Installation Methods See 7.3.1 Install/replace syringe.

In order to ensure infusion accuracy, when the ambient temperature changes significantly, the device needs to be re-calibrated, calibration method See Section 10 Accuracy Calibration for Syringe.

Please strictly follow the requirements described in Section 10 to calibrate and use the Syringe when change to a new Syringe from a different manufacturer. Otherwise, the infusion accuracy may be compromised.

## 12. Technical Specification

According to IEC60601-2-24 standard, we tested and obtained the trumpet and flow rate graphs under the conditions of 1mL, 5mL, positive and negative back pressure, etc. The specific data are reflected in the IEC60601-2-24 test reports, and the relevant graphs will update in this section accordingly.

- 1) The methods of controlling Bolus volume before occlusion: The pressure in the occlusion pipeline is released to control the bolus volume by controlling the inversion of the stepper motor.
- 2) Storage time for the electronic memory after power off: same as the product lifetime.
- 3) The maximum volume that the pump can deliver under a single fault condition: 0.3mL.
- 4) Device calibration is measured in ml.
- 5) Minimum flow rate performance curve (1 mL/h)
  - a. The rising curve for KDL syringe with the minimum flow rate during the first two hours of operation.

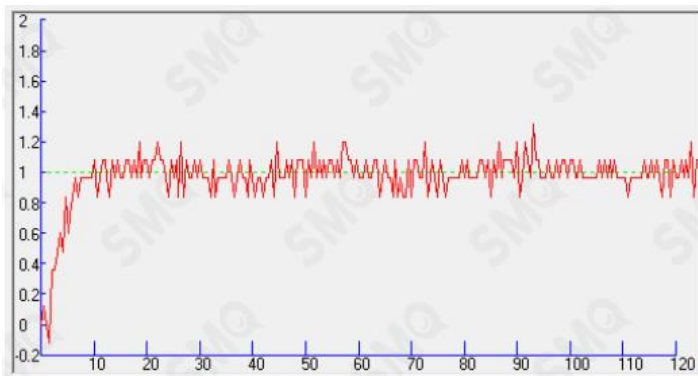

In the above figure, the dashed line shows the set flow rate (1

mL/h in this figure), and the solid line is the continuous connection line for the average flow rate during a sampling period.

- b. The trumpet curve for KDL syringe with the minimum flow rate during the second hour of operation.

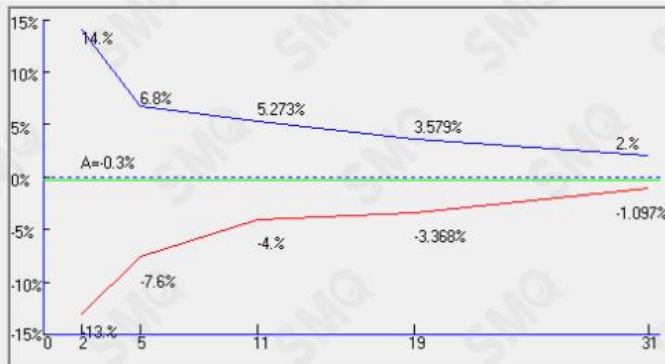

The dashed line in green color is the final value that the infusion error of the device is eventually converging to. The solid blue line above the dashed line is the maximum positive deviation during the second hour of operation. The solid red line below the dashed line is the maximum negative deviation during the second hour of operation.

- c. The trumpet curve for KDL syringe with the minimum flow rate during the last hour of the run.

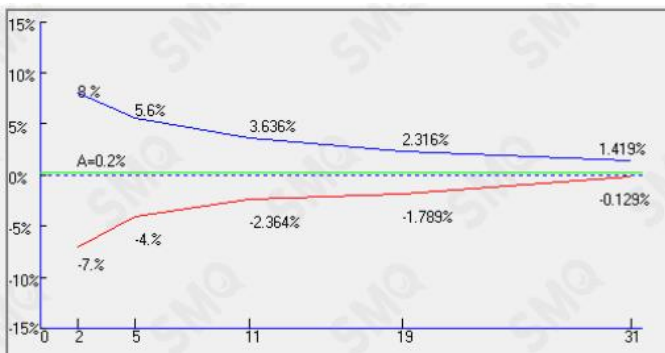

The green dashed line is the value where the device perfusion

error finally converges. The solid blue line above the dashed line is the maximum positive deviation within the hour of the run. The solid red line below the dashed line is the maximum negative deviation within the last hour.

- 6) Intermediate flow rate performance curve (5 mL/h)
  - a. The rising curve for KDL syringe with the intermediate flow rate during the first two hours of operation.

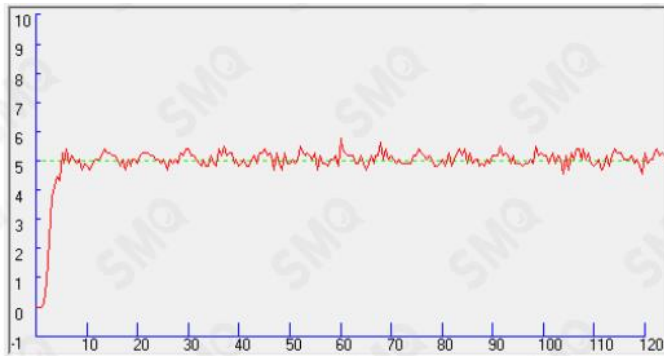

- b. The trumpet curve for KDL syringe with the intermediate flow rate during the second hour of operation.

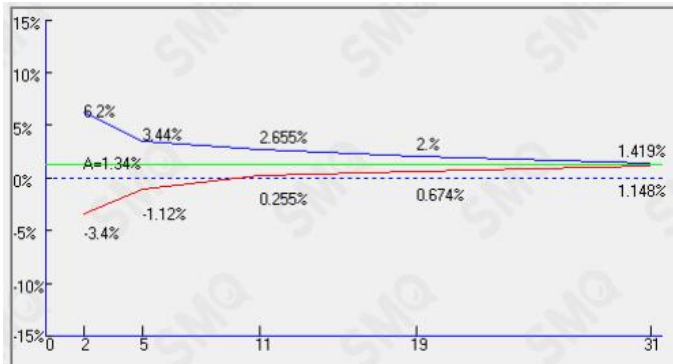

- c. The trumpet curve for KDL syringe with the intermediate flow rate during the last hour of the run.



7) Intermediate flow rate and back pressure +13.33kPa performance curve

a. The rising curve for KDL syringe with the Intermediate flow rate and back pressure +13.33kPa during the first 2h of the test period.

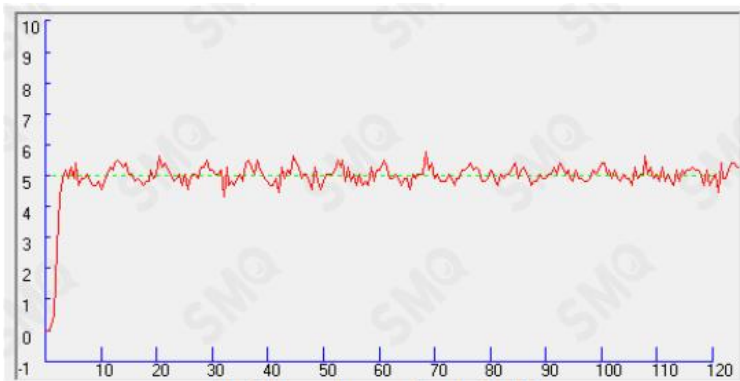

b. The trumpet curve for KDL syringe with the Intermediate flow rate and back pressure +13.33kPa during the second hour of the test period.

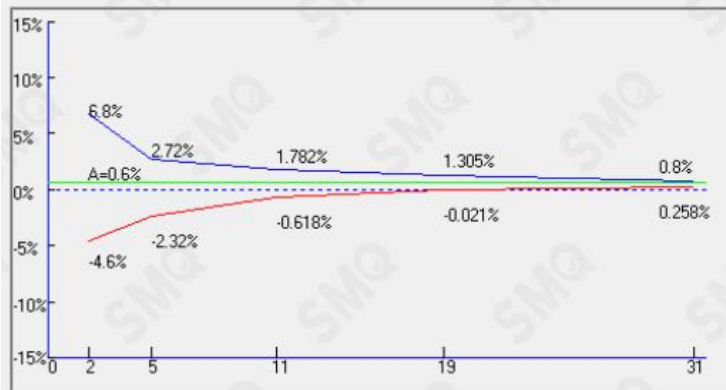

8) Intermediate flow rate and back pressure -13.33kPa performance curve.

a. The rising curve for KDL syringe with the Intermediate flow rate and back pressure -13.33kPa during the first 2h of the test period.

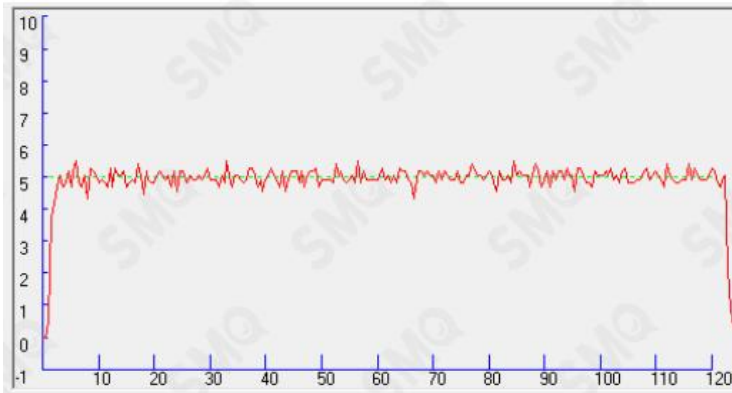

b. The trumpet curve for KDL syringe with the Intermediate flow rate and back pressure -13.33kPa during the second hour of the test period.

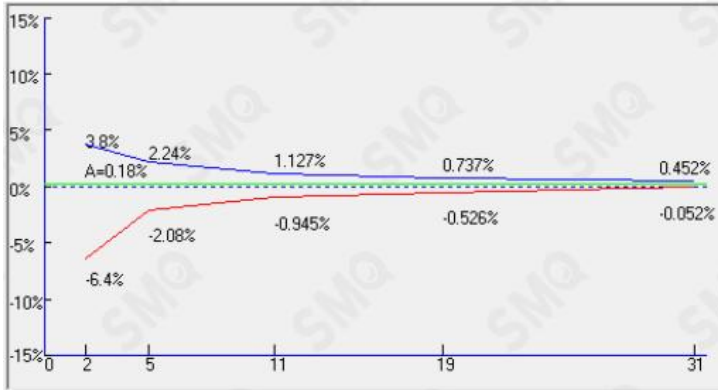

### 13. Restore to factory setting

Default factory setting as below:

No.	Parameter	Factory presets
1	Brightness level	Level 3
2	System sound level	Level 3
3	Night mode sound level	Level 3
4	Night mode brightness level	Level 3
5	Occlusion pressure level	1000mmHg
6	Night mode	Close
7	Infusion mode	Rate mode
8	KVO	Constant KVO
9	KVO rate	1.00mL
10	Call Back Time	2 min
11	Near End Of Infusion time	5 min
12	Auto screen lock time	5 min
13	Night mode start time	19:00:00

14	Night mode end time	09:00:00
15	Bolus rate	1200.00mL/h
16	Purge rate	1200.00mL/h
17	Bolus volume	5.00mL
18	Purge volume	15.00mL

## **14. Use, Maintenance and Removal of the Internal Battery**

The device has an internal rechargeable lithium battery with the following specification: 21700/4800mAh\*2PCS.

Daily maintenance of the battery:

When the pump is not used for a long time, the internal battery should be fully charged at least once for every 3 months by connecting the device to the mains power to help saving the battery life.

Contact the customer service immediately if the internal battery cannot be charged or cannot work normally. Do not disassemble it by yourself. For the healthcare providers who have the ability to repair a device, we will provide training to the related personnel from these facilities.

The device has a internal disposable button battery designed to last longer than 8 years, when the set time is exceeded, need to be disposed with the device in accordance with the instructions for waste disposal in this manual 16.

## **15. Service and Maintenance**

**Check the pump before use:**

- 1) Check whether there are foreign objects inside the power outlet (such as drug solution residue), and confirm that the device startup self-test

is normal.

- 2) Select the correct syringe specification, check the battery power, and charge it in time when the power is low.

**During use:**

- 1) To avoid giving an incorrect dosage of drug to a patient, please disconnect the pump from the patient before changing a device.
- 2) Please make sure that the infusion line is not kinked. Insert the needle to the vein on a part of the patient's body where it is not likely to be squeezed or pressed.
- 3) To prevent the spilled drug solution on the pump surface from getting into the inside of the device, wipe it dry immediately if there is a spill.

**Storage and daily maintenance:**

- 1) To keep the device clean, wipe it clean for at least once a month, which can prevent the corrosion caused by the drug solution and avoid the mobility of the mechanical parts being affected by the dried solution.
- 2) Use a clean and damp cloth or an alcohol pad to wipe clean the device. Take caution to avoid any liquid from entering the device. If disinfection is required, commonly used disinfectants can be used. After using the disinfectant, after wetting with a soft cloth in water, wring out the soft cloth for scrub treatment. When using disinfectants, follow their instructions.
- 3) Check the Low battery Alarm time of the device at least once a month. Make the device standby when the battery is low in non-clinical use, start timing when you hear the alarm of "low battery", and the alarm time should be more than 30 minutes.

**Disinfection method:**

If disinfection is required, commonly used disinfectants can be used. After using the disinfectant, after wetting with a soft cloth in water,

wring out the soft cloth for scrub treatment. When using disinfectants, follow their instructions.

## **16. Waste Disposal**

### **16.1. Battery**

Please follow local regulations to dispose of used batteries.

### **16.2. Syringe**

After use, please dispose of the syringe in accordance with the relevant medical waste disposal regulations.

### **16.3. Syringe pump**

This device is designed to last 8 years and should be scrapped after it has exceeded the lifetime. End-of-life syringe pumps can be sent back to the dealer who sold the product or to the Company for proper recycling.

## **17. Electromagnetic Compatibility**

Special precautions regarding Electromagnetic Compatibility (EMC) are required for this device. Must install and use in accordance with the electromagnetic compatibility information specified in this instruction.

Portable and mobile RF communication devices may have an impact on this device.

Must use the cables and accessories provided by this device, and the cable information as follows:

The name of the cable	Length
The power adapter	2.9 m

In addition to cables (transducers) sold as spare parts for internal

components, the use of accessories and cables (transducers) other than specified may result in an increase in device or system emission or a decrease in immunity.

Devices or systems should not be used close to or stacked with other devices, and if they must be accessed or stacked, observe to verify that they can run normally in the configuration they are using.

The basic performance is to operate on a network power supply (including an internal battery) connection.

Name	Specific Description
The network power supply (including the internal battery) is connected to run	At the intermediate rate of 5.00mL/h and the VTBI of $\geq 10\text{mL}$ , start to operation, infusion accuracy error less than $\pm 1.5\%$ and the operation is normal during the process, there should be no abnormal phenomena and failures.

Note: The emissions characteristics of this device make it suitable for use in industrial areas and hospitals (CISPR 11 class A). If it is used in a residential environment (for which CISPR 11 class B is normally required) this device might not offer adequate protection to radio-frequency communication services. The user might need to take mitigation measures, such as relocating or re-orienting the device.

<b>Guidance and manufacture's declaration – electromagnetic emission</b>	
The syringe pump MS39 CC is intended for use in the electromagnetic environment specified below. The customer or the user of the syringe pump MS39 CC should assure that it is used in such and environment.	
<b>Emissions test</b>	<b>Compliance</b>
RF emissions CISPR 11	Group 1
RF emissions CISPR 11	Class A
Harmonic emissions IEC 61000-3-2	Not applicable
Voltage fluctuations / flicker emissions IEC 61000-3-3	Not applicable

<b>Guidance and manufacture's declaration – electromagnetic immunity</b>
The syringe pump MS39 CC is intended for use in the electromagnetic environment specified below. The customer or the user of syringe pump MS39 CC should assure

that it is used in such an environment.

<b>Immunity test</b>	<b>IEC 60601 test level</b>	<b>Compliance level</b>
Electrostatic discharge (ESD) IEC 61000-4-2	±8 kV contact ±2 kV, ±4 kV, ±8 kV, ±15 kV air	±8 kV contact ±2 kV, ±4 kV, ±8 kV, ±15 kV air
Electrical fast transient/burst IEC 61000-4-4	±2 kV for power supply lines ±1 kV signal input/output 100kHz repetition frequency	±2 kV for power supply lines Not Applicable 100kHz repetition frequency
Surge IEC 61000-4-5	±0.5kV,±1 kV differential mode ±0.5kV,±1 kV,±2 kV common mode	±0.5kV,±1 kV differential mode Not Applicable
Voltage dips, short interruptions and voltage variations on power supply input lines IEC 61000-4-11	0 % UT; 0,5 cycle At 0°, 45°, 90°, 135°, 180°, 225°, 270° and 315°. 0 % UT; 1 cycle and 70 % UT; 25/30 cycles; Single phase: at 0°. 0 % UT; 250/300 cycle	0 % UT; 0,5 cycle At 0°, 45°, 90°, 135°, 180°, 225°, 270° and 315°. 0 % UT; 1 cycle and 70 % UT; 25/30 cycles; Single phase: at 0°. 0 % UT; 250/300 cycle
Power frequency (50/60Hz) magnetic field IEC 61000-4-8	30 A/m 50Hz/60Hz	30 A/m 50Hz/60Hz

Note:  $U_T$  is the a.c. mains voltage prior to application of the test level.

**Guidance and manufacture’s declaration – electromagnetic immunity**

The syringe pump MS39 CC is intended for use in the electromagnetic environment specified below. The customer or the user of syringe pump MS39 CC should assure that it is used in such an environment.

<b>Immunity test</b>	<b>IEC 60601 test level</b>	<b>Compliance level</b>
Conducted RF IEC61000-4-6	3 V 0,15 MHz – 80 MHz 6 V in ISM bands between 0,15 MHz and 80 MHz 80%AM at 1 kHz	3 V 0,15 MHz – 80 MHz 6 V in ISM bands between 0,15 MHz and 80 MHz 80%AM at 1 kHz
Radiated RF IEC61000-4-3	3 V/m 80 MHz – 2,7 GHz 80%AM at 1 kHz	3 V/m 80 MHz – 2,7 GHz 80%AM at 1 kHz

NOTE 1 At 80 MHz and 800 MHz, the higher frequency range applies.

NOTE 2 These guidelines may not apply in all situations. Electromagnetic propagation

is affected by absorption and reflection from structures, objects and people.

<sup>a</sup> Field strengths from fixed transmitters, such as base stations for radio (cellular/cordless) telephones and land mobile radios, amateur radio, AM and FM radio broadcast and TV broadcast cannot be predicted theoretically with accuracy. To assess the electromagnetic environment due to fixed RF transmitters, an electromagnetic site survey should be considered. If the measured field strength in the location in which the syringe pump MS39 CC is used exceeds the applicable RF compliance level above, the syringe pump MS39 CC should be observed to verify normal operation. If abnormal performance is observed, additional measures may be necessary, such as reorienting or relocating the syringe pump MS39 CC.

<sup>b</sup> Over the frequency range 150 kHz to 80 MHz, field strengths should be less than 3 V/m.

**Guidance and manufacturer’s declaration - electromagnetic Immunity**

The syringe pump MS39 CC is intended for use in the electromagnetic environment specified below. The customer or the user of the syringe pump MS39 CC should assure that it is used in such an environment

Radiated RF IEC6100 0-4-3 (Test specifications for ENCLOSURE PORT IMMUNITY to RF wireless communications device)	Test Frequency (MHz)	Band (MHz)	Service	Modulation	IEC 60601-1-2 Test Level (V/m)	Compliance level (V/m)
	385	380 – 390	TETRA 400	Pulse modulation 18 Hz	27	27
	450	430 – 470	GMRS 460, FRS 460	FM ± 5 kHz deviation 1 kHz sine	28	28
	710	704 – 787	LTE Band 13, 17	Pulse modulation 217 Hz	9	9
	745					
	780					
	810	800 – 960	GSM 800/900, TETRA 800, iDEN 820, CDMA 850, LTE Band 5	Pulse modulation 18 Hz	28	28
	870					
	930					
	1720	1 700	GSM 1800; CDMA 1900;	Pulse modulation 217 Hz	28	28
	1845	–				
	1970	1 990				

			GSM 1900; DECT; LTE Band 1, 3, 4, 25; UMTS			
	2450	2 400 – 2 570	Bluetooth, WLAN, 802.11 b/g/n, RFID 2450, LTE Band 7	Pulse modulation 217 Hz	28	28
	5240	5 100	WLAN	Pulse modulation	9	9
	5240	–	802.11	217 Hz		
	5785	5 800	a/n			

NOTE If necessary to achieve the IMMUNITY TEST LEVEL, the distance between the transmitting antenna and the ME device or ME SYSTEM may be reduced to 1 m. The 1 m test distance is permitted by IEC 61000-4-3.

- a) For some services, only the uplink frequencies are included.
- b) The carrier shall be modulated using a 50 % duty cycle square wave signal.
- c) As an alternative to FM modulation, 50 % pulse modulation at 18 Hz may be used because while it does not represent actual modulation, it would be worst case.

The MANUFACTURER should consider reducing the minimum separation distance, based on RISK MANAGEMENT, and using higher IMMUNITY TEST LEVELS that are appropriate for the reduced minimum separation distance. Minimum separation distances for higher IMMUNITY TEST LEVELS shall be calculated using the following equation:

$$E = \frac{6}{d} \sqrt{P}$$

Where P is the maximum power in W, d is the minimum separation distance in m, and E is the IMMUNITY TEST LEVEL in V/m.

**Guidance and manufacturer’s declaration - electromagnetic Immunity**

The syringe pump MS39 CC is intended for use in the electromagnetic environment specified below. The customer or the user of the syringe pump MS39 CC should assure that it is used in such an environment.

Radiated fields in close proximity IEC61000-4-39 (Test specifications for ENCLOSURE	Test Frequency	Modulation	IEC 60601-1-2 Test Level (A/m)	Compliance level (A/m)
	30 kHz	CW	8	8
	134.2 kHz	Pulse	65	65

PORT IMMUNITY to proximity magnetic fields)		modulation 2.1 kHz		
	13.56 MHz	Pulse modulation 50 kHz	7,5	7,5

## 18. Antistatic Precautions

The MS39 CC Syringe pump has been tested and comply with medical device standard IEC 60601-1-8.

When using this device, the user should not touch the pins of connectors marked with an electrostatic discharge warning symbol and should not connect to these connectors unless electrostatic discharge precautions are used.

The operator should be aware of the following things:

a) Unless appropriate preventive measures have already been taken, do not use hand or hand tool to touch connectors with electrostatic discharge warning signs. Preventive measures include: 1) Methods for preventing electrostatic charge accumulation (such as air conditioning, air humidification, floor conductive coating or Non-synthetic clothing); 2) Discharge electrostatic charge from human body to the framework of device, or to the ground, or to a large piece of metal; 3) Use a wrist band to connect human body to the device or to the ground.

b) All staff who may be in contact with connectors with electrostatic discharge warning signs should receive training, including all clinical/biomedical engineering and healthcare personnel.

c) Electrostatic discharge training should include the introduction of static charges in the theory of physics, the voltage that may be produced in normal practice, and the damage to the electronic components caused by the electrostatic charge from an operator. Further, methods for how to

prevent electrostatic charge accumulation should be provided, as well as how and why to discharge the electrostatic from human body to the framework of device or to the ground, and how to use wrist band to connect someone's body to the device or to the ground.

**19. Packaging and Accessories**

The list of recommended accessories for use with this device (single unit) is as follows:

Attachment	Quantity	Unit
User manual	1	Book
Power adapter	1	Set
Other accessories can be found in the packing list.		

**Legal manufacturer:** MDKMed Medical Technology Co., Ltd.

**Address:** 502A, Building 7, No. 22, Xinyan Road, Donghu Street, Linping District, Hangzhou City, Zhejiang Province, P. R China 311323

**After sale service:** MDKMed Medical Technology Co., Ltd.

**Tel:** 400-880-8392

**Email:** sales@graseby.com

**Web:** <http://www.graseby.com>

**Revision date:** 07-08-2025

**Part No.:** 07.01.0217A



European Authorized Representative:

MedNet EC-REP C IIb GmbH

Borkstrasse 10

48163 Münster, Germany